

PROJECT I.D. NO. 33 / 6 / 5 & 8E
 TITLE : 1985 RECONSTRUCTION OF CTH "E"
 SCALE: 1"=50' HORIZONTAL ; 1"=2' VERTICAL
 SHEET NO. 1

PATRICK & NANCY PRIEBE

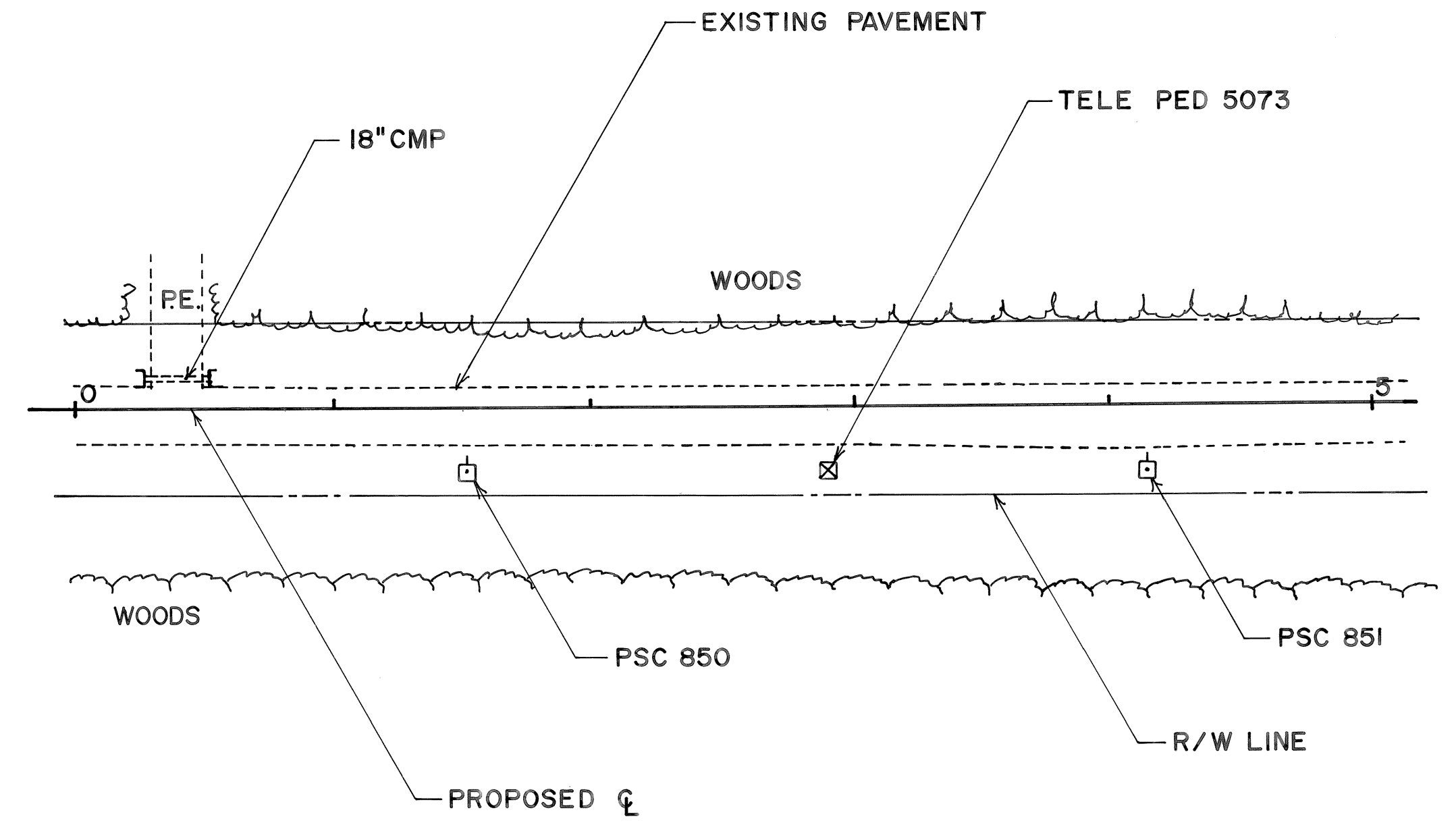

RIB MOUNTIAN GLASS , INC.

PLAN	SURVEYED	BY	DATE
	PLOTTED		
NOTE BOOK NO.	CHECKED		
	RT. OF WAY CHECKED		

BENCHMARKS

82	4" SPIKE W/ORANGE TAB 18" OFF THE GROUND ON THE WEST FACE OF A 4" POPLAR 69' EAST OF ϕ AT STA 4+19. ELEVATION = 1450.23
----	--

PROFILE	SURVEYED	BY	DATE
	PLOTTED		
NOTE BOOK NO.	GRADES CHECKED		
	STRUCTURE NOTATIONS CHKD		

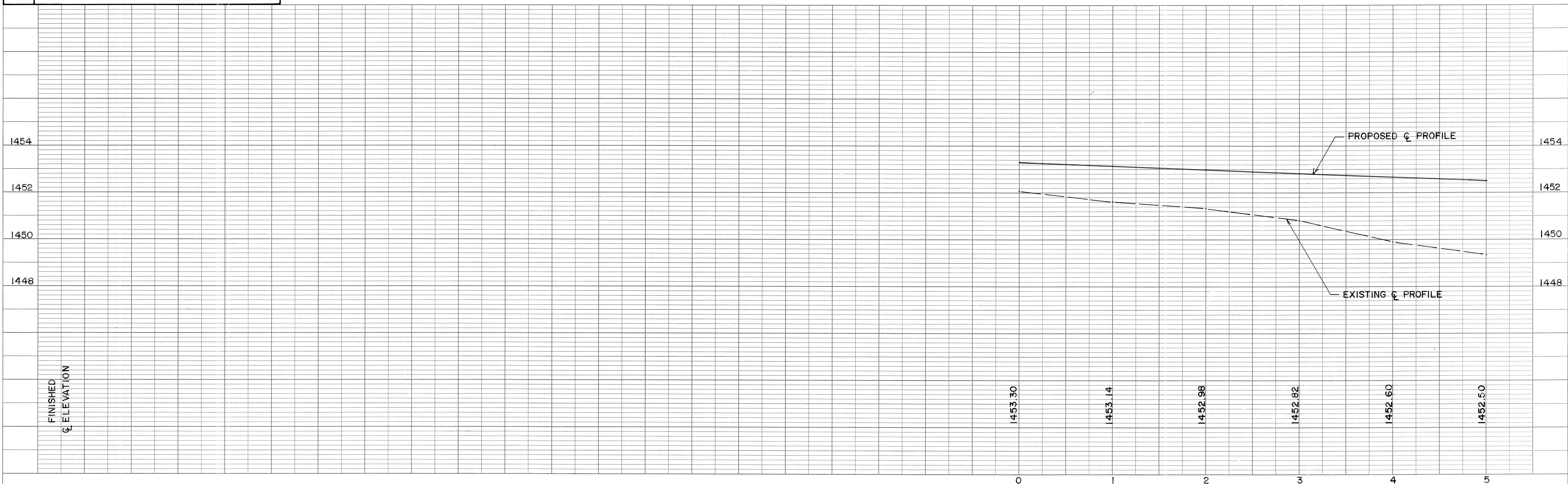

PATRICK & NANCY PRIEBE

WALTER & RON PREY

PROJECT I.D. NO. 33/6/5 & 8E
TITLE: 1985 RECONSTRUCTION OF CTH "E"
SCALE: 1" = 50' HORIZONTAL ; 1" = 2' VERTICAL
SHEET NO. 2

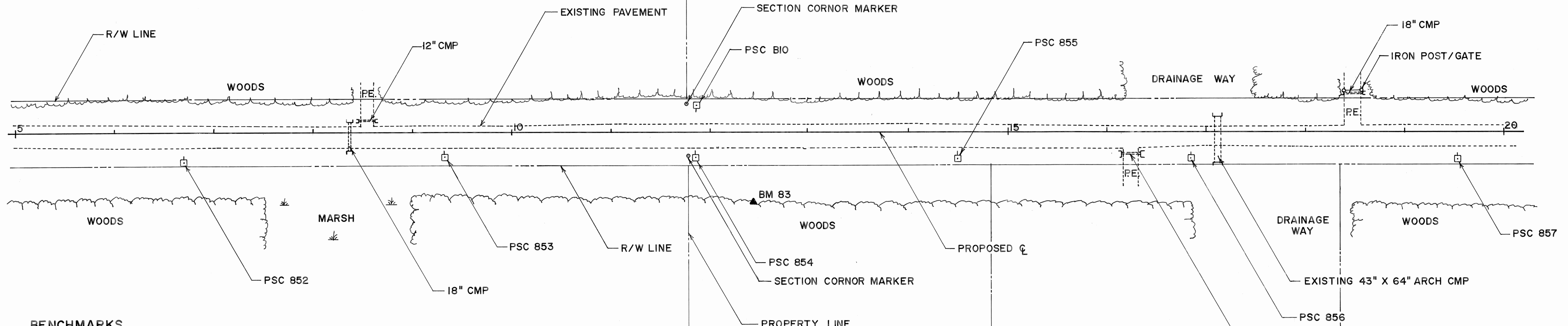
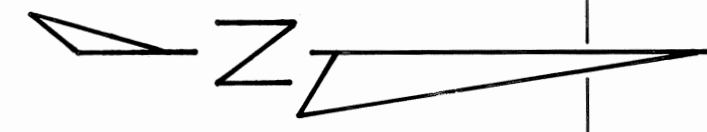

BENCHMARKS

83	4" SPIKE W/ORANGE TAB 18" OFF THE GROUND ON THE WEST FACE OF A 8" POPLAR 69' EAST OF ϕ AT STA 12+41. ELEVATION = 1452.06
----	---

RIB MOUNTAIN GLASS, INC.

JOESPH & ANN HAINER

WILLIAM & LAVONNE CERVAC

KEVIN & MARY BLUME

PLAN

DATE	
BY	
SURVEYED	
PLOTTED	
GRADES CHECKED	
STRUCTURE NOTATIONS CHKD	
NOTE BOOK NO.	

PROFILE

DATE	
BY	
SURVEYED	
PLOTTED	
GRADES CHECKED	
STRUCTURE NOTATIONS CHKD	
NOTE BOOK NO.	

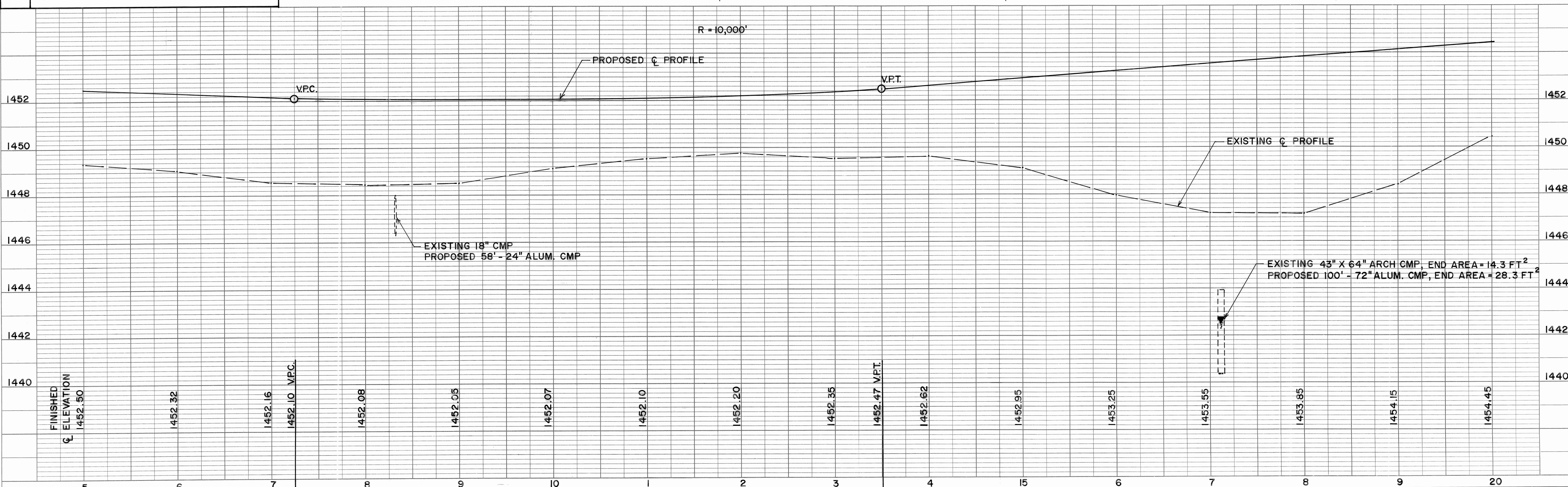

WALTER & RON PREY

LE ROY WEISMAN

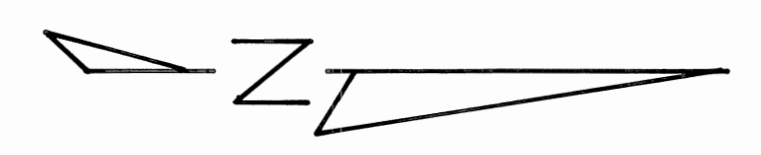

PLAN
 SURVEYED, PLOTTED, CHECKED, RECHECKED, DATE, BY, NO., NOTE BOOK, REL. OF WAY CHECKED

PROFILE
 SURVEYED, PLOTTED, CHECKED, RECHECKED, DATE, BY, NO., NOTE BOOK, STRUCTURE NOTATIONS CHKD

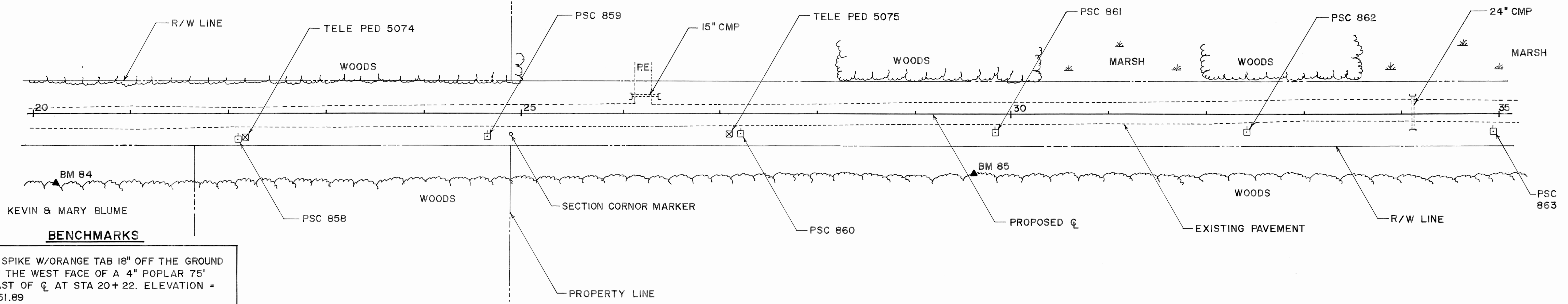

BENCHMARKS	
84	4" SPIKE W/ORANGE TAB 18" OFF THE GROUND ON THE WEST FACE OF A 4" POPLAR 75' EAST OF CL AT STA 20+22. ELEVATION = 1451.89
85	4" SPIKE W/ORANGE TAB 18" OFF THE GROUND ON THE WEST FACE OF A 6" POPLAR 62' EAST OF CL AT STA 29+50. ELEVATION = 1454.60

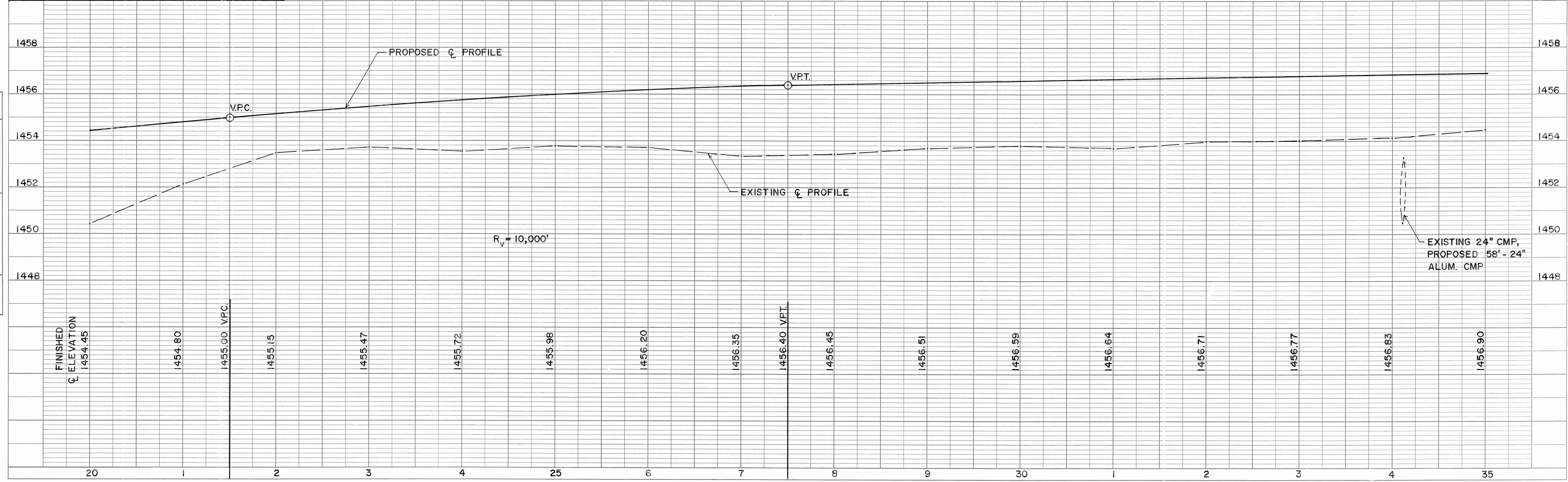

PROJECT I.D. NO. 33/6/5 & 8E
 TITLE: 1985 RECONSTRUCTION OF CTH "E"
 SCALE: 1"=50' HORIZONTAL ; 1"=2' VERTICAL
 SHEET NO. 4

PLAN
 SURVEYED, PLOTTED, CHECKED, ALIGNED, RT. OF WAY CHECKED.
 NOTE BOOK NO. _____
 DATE _____ BY _____

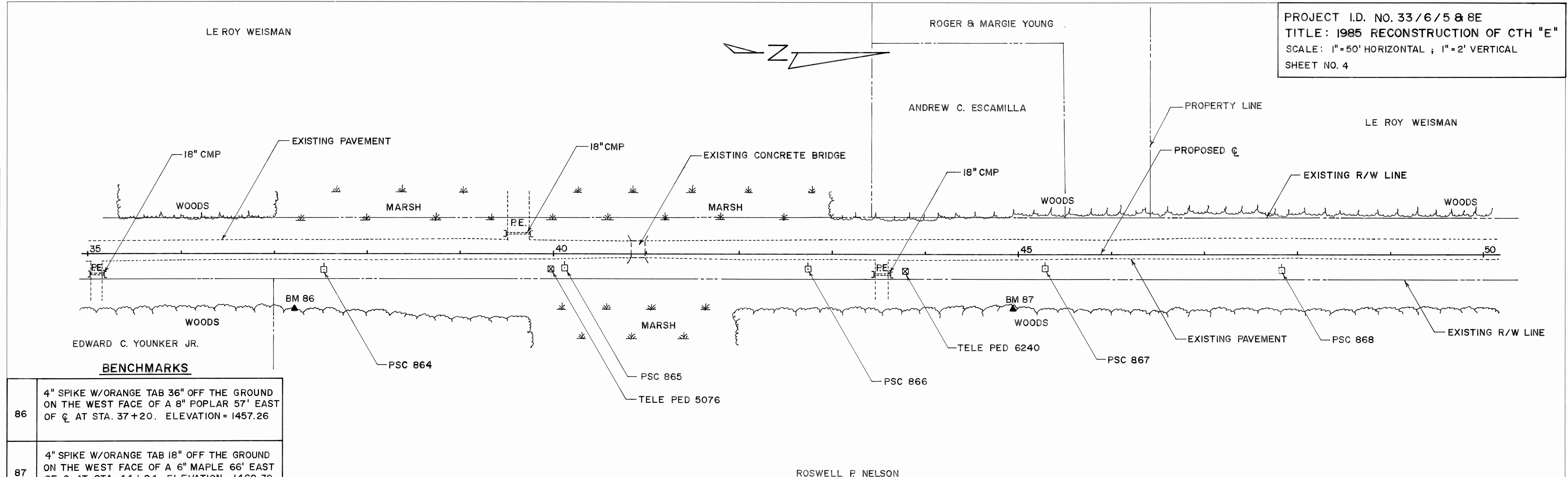

BENCHMARKS

86	4" SPIKE W/ORANGE TAB 36" OFF THE GROUND ON THE WEST FACE OF A 8" POPLAR 57' EAST OF CL AT STA. 37+20. ELEVATION = 1457.26
87	4" SPIKE W/ORANGE TAB 18" OFF THE GROUND ON THE WEST FACE OF A 6" MAPLE 66' EAST OF CL AT STA. 44+94. ELEVATION = 1460.39

PROFILE
 SURVEYED, PLOTTED, CHECKED, STRUCTURE NOTATIONS CHKD.
 NOTE BOOK NO. _____
 DATE _____ BY _____

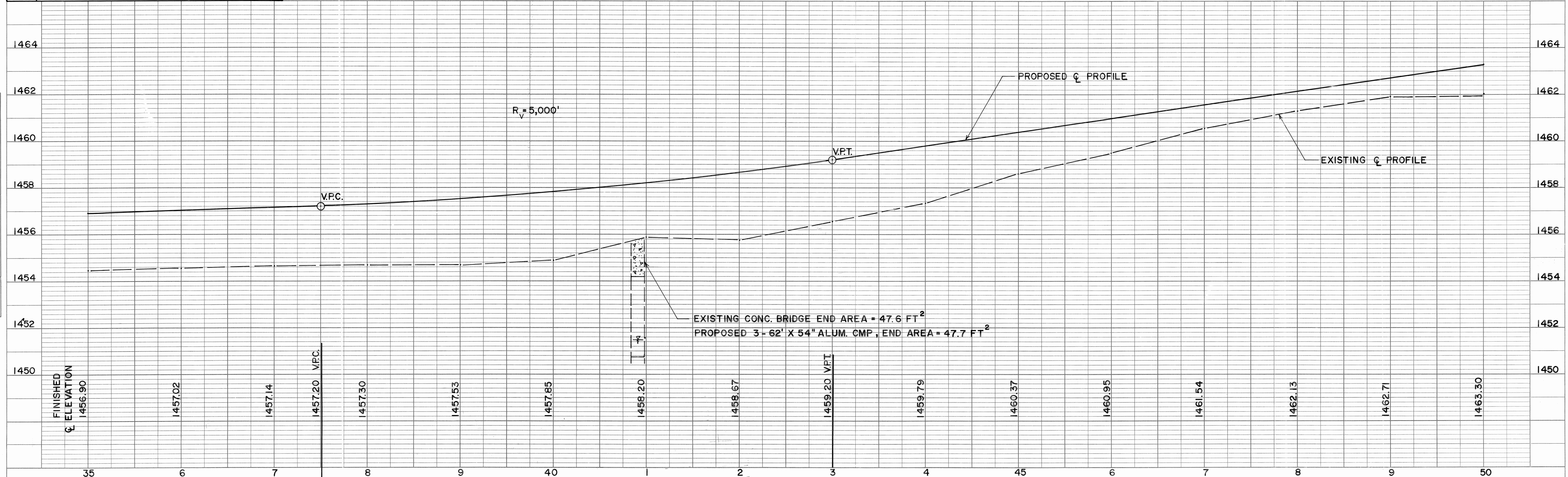

PROJECT I.D. NO. 33/6/5 & 8E
 TITLE: 1985 RECONSTRUCTION OF CTH "E"
 SCALE: 1"=50' HORIZONTAL; 1"=2' VERTICAL
 SHEET NO. 5

LE ROY WEISMAN

DOSS C. BENDER

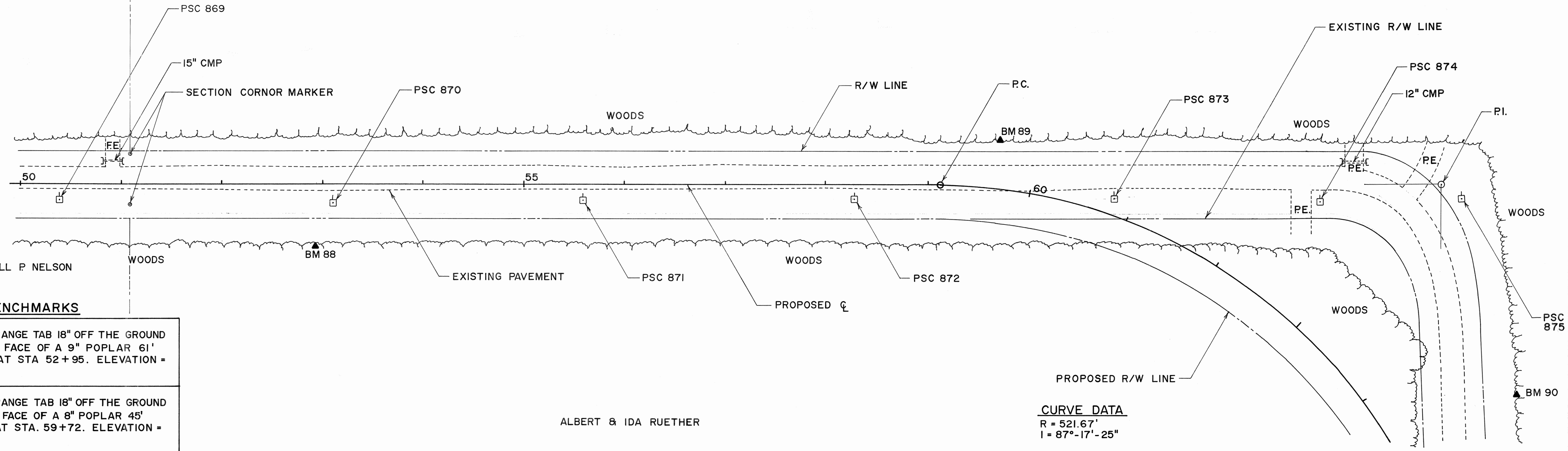
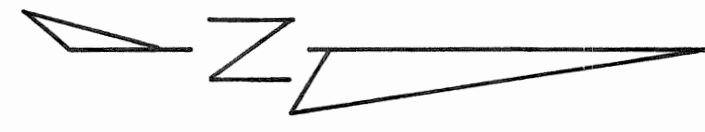

BENCHMARKS

88	4" SPIKE W/ORANGE TAB 18" OFF THE GROUND ON THE WEST FACE OF A 9" POPLAR 61' EAST OF CL AT STA 52+95. ELEVATION = 1464.67
89	4" SPIKE W/ORANGE TAB 18" OFF THE GROUND ON THE EAST FACE OF A 8" POPLAR 45' WEST OF CL AT STA. 59+72. ELEVATION = 1468.71

ALBERT & IDA RUETHER

CURVE DATA
 R = 521.67'
 I = 87°-17'-25"

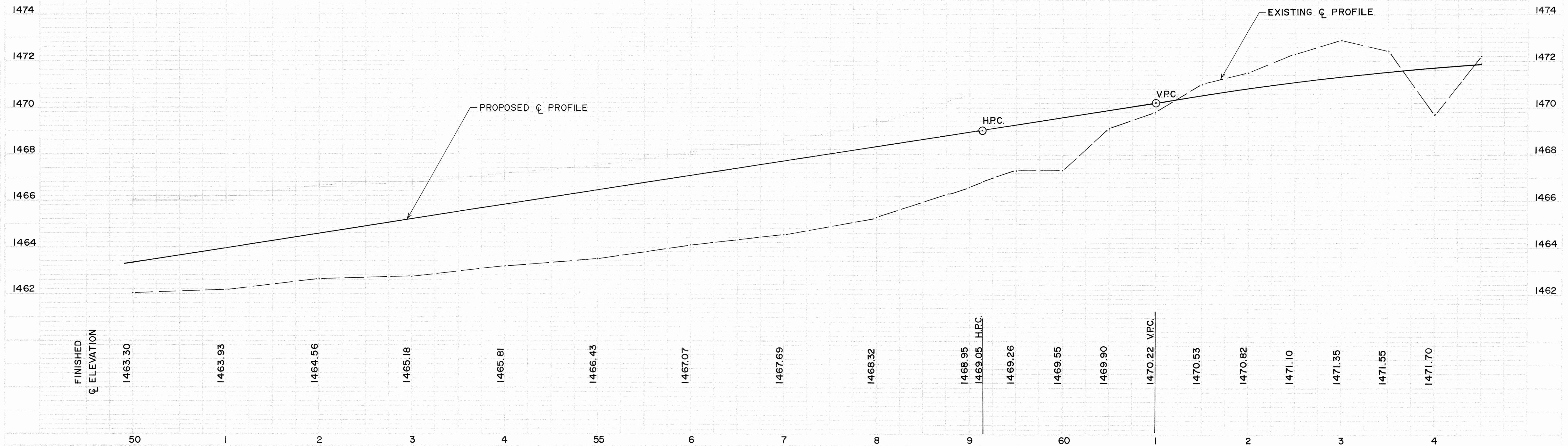

ARTHUR & JANE HANAT

PROJECT I.D. NO. 33/6/5 & 8E
 TITLE: 1985 RECONSTRUCTION OF CTH "E"
 SCALE: 1"=50' HORIZONTAL; 1"=2' VERTICAL
 SHEET NO. 6

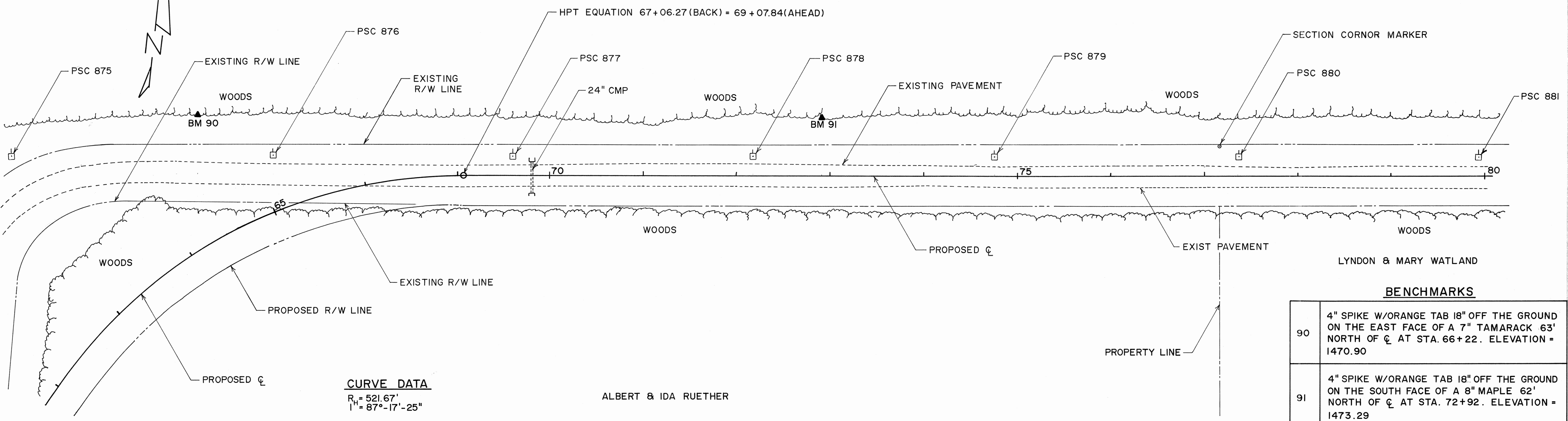

CURVE DATA
 $R_v = 521.67'$
 $I_H = 87^\circ - 17' - 25''$

ALBERT & IDA RUETHER

BENCHMARKS

90	4" SPIKE W/ORANGE TAB 18" OFF THE GROUND ON THE EAST FACE OF A 7" TAMARACK 63' NORTH OF CL AT STA. 66+22. ELEVATION = 1470.90
91	4" SPIKE W/ORANGE TAB 18" OFF THE GROUND ON THE SOUTH FACE OF A 8" MAPLE 62' NORTH OF CL AT STA. 72+92. ELEVATION = 1473.29

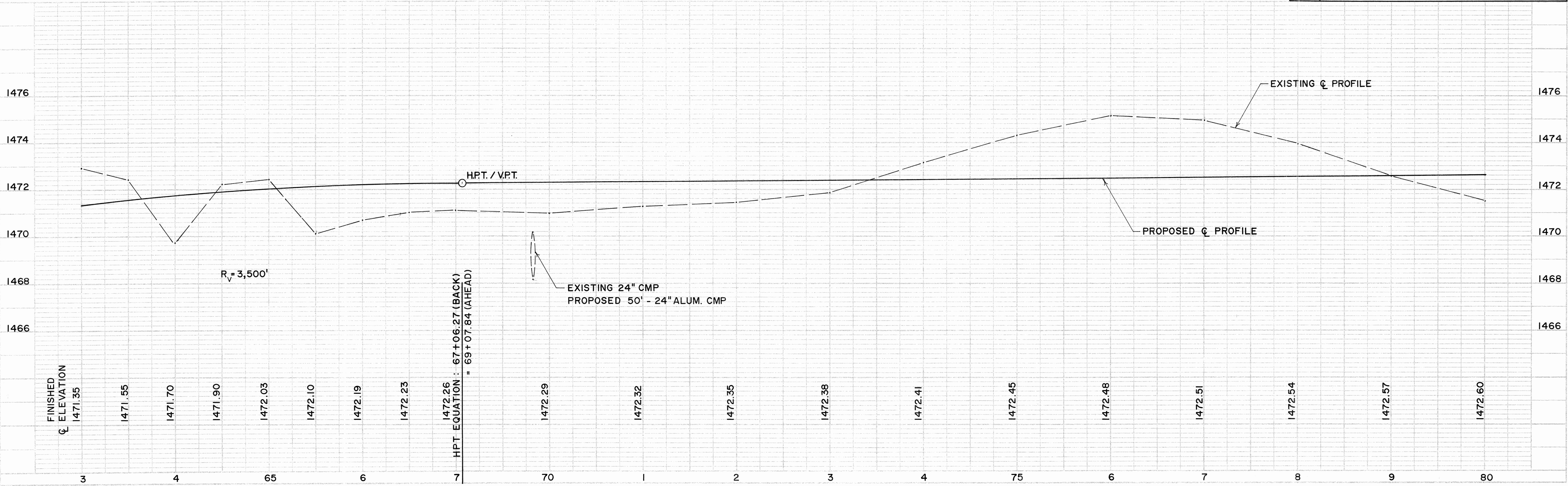

PROJECT I.D. NO. 33/6/5 & 8E
 TITLE: 1985 RECONSTRUCTION OF CTH "E"
 SCALE: 1"=50' HORIZONTAL ; 1"=2' VERTICAL
 SHEET NO. 7

ARTHUR & JANE HANAT

LYNDON & MARY WATLAND

MESLER REALTY CO., INC.

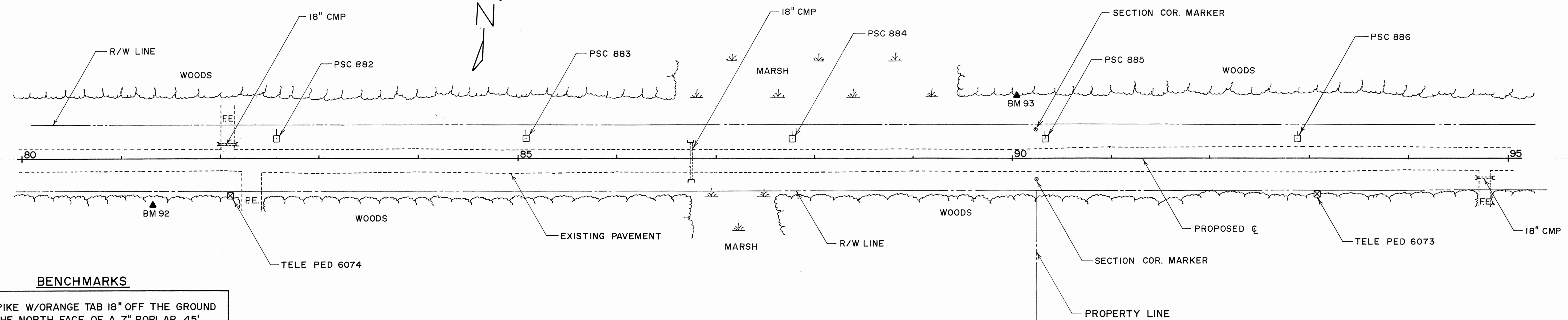

BENCHMARKS

92	4" SPIKE W/ORANGE TAB 18" OFF THE GROUND ON THE NORTH FACE OF A 7" POPLAR 45' SOUTH OF C AT STA. 81+32. ELEVATION = 1469.37
93	4" SPIKE W/ORANGE TAB 18" OFF THE GROUND ON THE SOUTH FACE OF A 8" BIRCH STUB 65' NORTH OF C AT STA. 90+03. ELEVATION = 1470.50

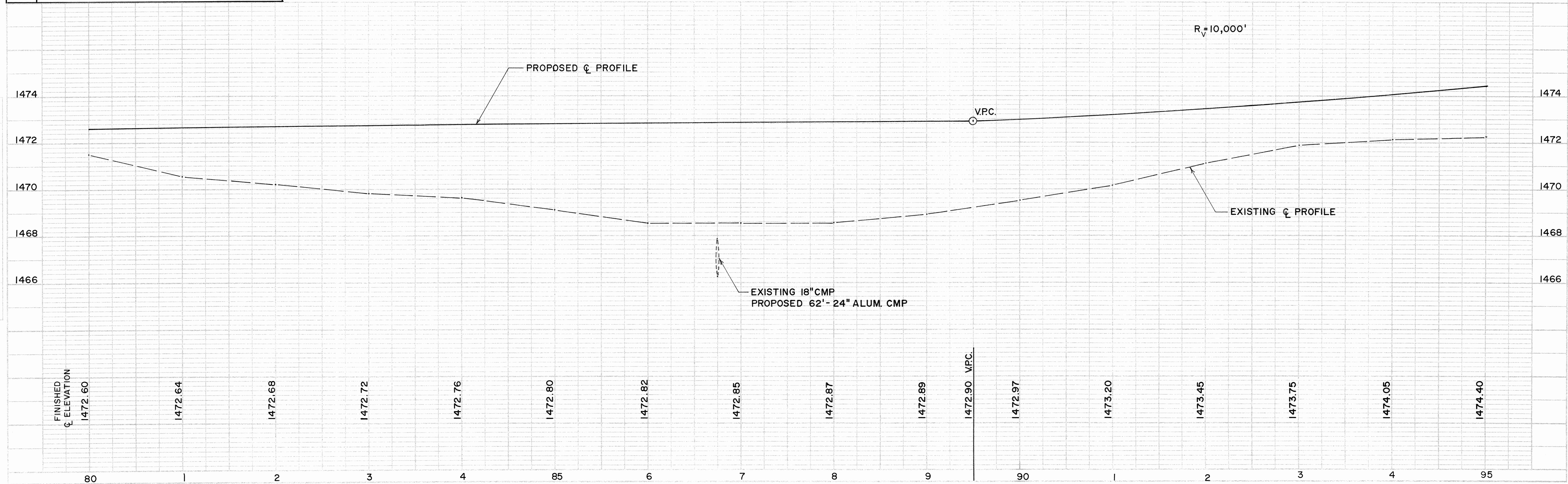

PLAN
 SURVEYED: _____
 PLOTTED: _____
 CHECKED: _____
 DATE: _____

PROFILE
 SURVEYED: _____
 PLOTTED: _____
 CHECKED: _____
 DATE: _____

PROJECT I.D. NO. 33/6/588E
 TITLE: 1985 RECONSTRUCTION OF CTH "E"
 SCALE: 1"=50' HORIZONTAL ; 1"=2' VERTICAL
 SHEET NO. 8

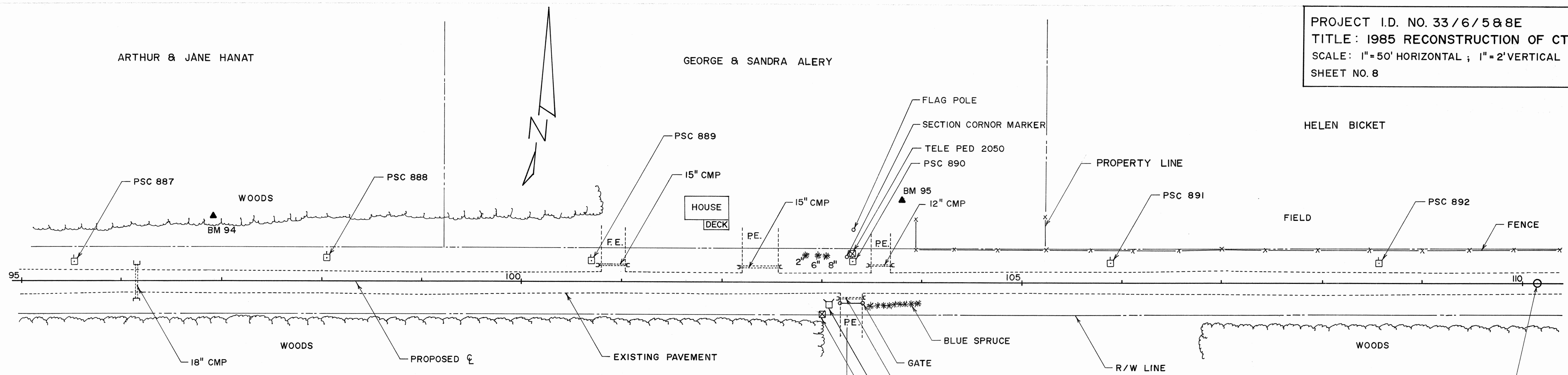

BENCHMARKS

94	4" SPIKE W/ORANGE TAB 18" OFF THE GROUND ON THE SOUTH FACE OF A 8" POPLAR 65' NORTH OF CL AT STA. 96+93. ELEVATION = 1471.93
95	4" SPIKE W/ORANGE TAB FLUSH WITH THE FACE OF A 20" MAPLE STUMP CUT OFF AT GROUND LEVEL 82' NORTH OF CL AT STA. 103+81. ELEVATION = 1479.19

MESLER REALTY CO., INC.

MRS. HAROLD KAPITZKE

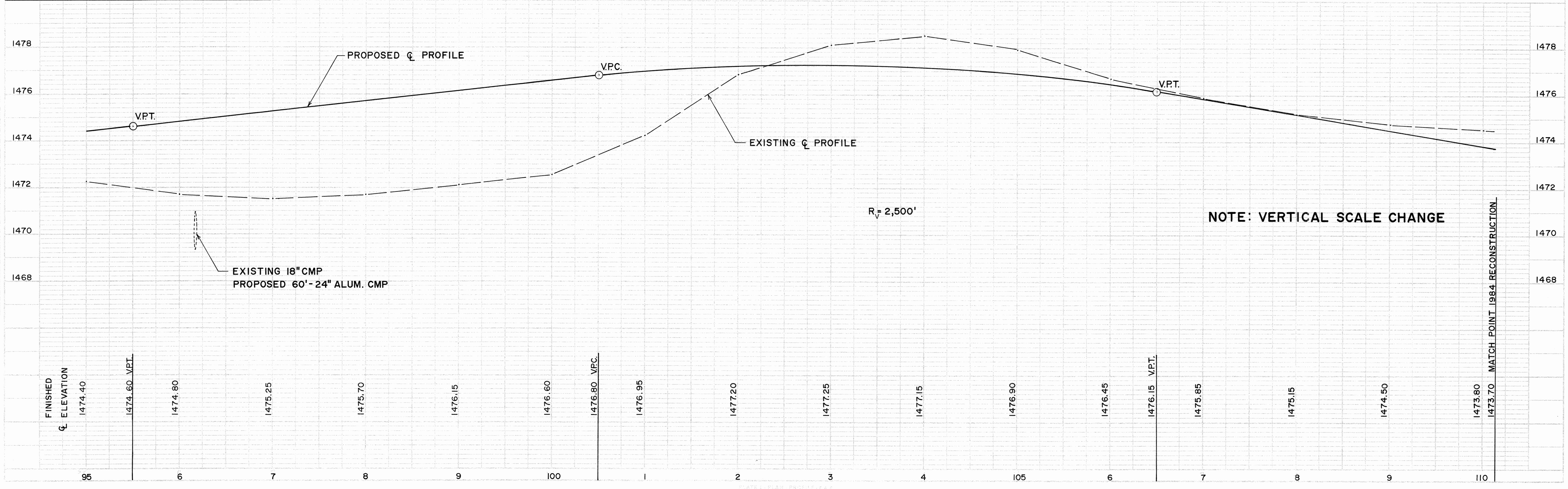

PROFILE
 DATE: 11/15/84
 DRAWN BY: J. J. HANAT
 CHECKED BY: J. J. HANAT
 SCALE: 1"=20' VERTICAL
 SHEET NO. 8 OF 8